

FLORIDA SOLAR



ENERGY CENTER[®]

Sun Position in Florida

Author

McCluney, Ross

Publication Number

FSEC-DN-4-83
Revised March 1985

Copyright

Copyright © Florida Solar Energy Center/University of Central Florida
1679 Clearlake Road, Cocoa, Florida 32922, USA
(321) 638-1000
All rights reserved.

Disclaimer

The Florida Solar Energy Center/University of Central Florida nor any agency thereof, nor any of their employees, makes any warranty, express or implied, or assumes any legal liability or responsibility for the accuracy, completeness, or usefulness of any information, apparatus, product, or process disclosed, or represents that its use would not infringe privately owned rights. Reference herein to any specific commercial product, process, or service by trade name, trademark, manufacturer, or otherwise does not necessarily constitute or imply its endorsement, recommendation, or favoring by the Florida Solar Energy Center/University of Central Florida or any agency thereof. The views and opinions of authors expressed herein do not necessarily state or reflect those of the Florida Solar Energy Center/University of Central Florida or any agency thereof.



Sun position in Florida

Ross McCluney
Principal Research Scientist

Florida Solar Energy Center

Described herein is a procedure for determining the path of the sun through the Florida sky relative to a solar collector array, a window, a skylight or an entire building — information needed by architects, engineers and others for shading and orientation calculations involved in active and passive building design. It can be used for positioning exterior shading devices for maximum benefit. This information can also be used to pinpoint solar collector shading problems.

The apparent paths of the sun in midwinter and mid-summer in central Florida are shown in Figure 1. In win-

versa, is provided in an FSEC research memorandum, RM-5-80. Each sun path curve plotted in Figures 3 through 5 is for the 21st day of the month indicated and for latitudes there indicated. For locations near the north and south zone boundaries, the solar positions given in Figures 3 - 5 will contain a small error, but one which is insignificant for most applications.

These data are calculated following a procedure published by the American Society of Heating, Refrigerating & Air Conditioning Engineers Inc. They give approximate positions only. True sun positions may differ from

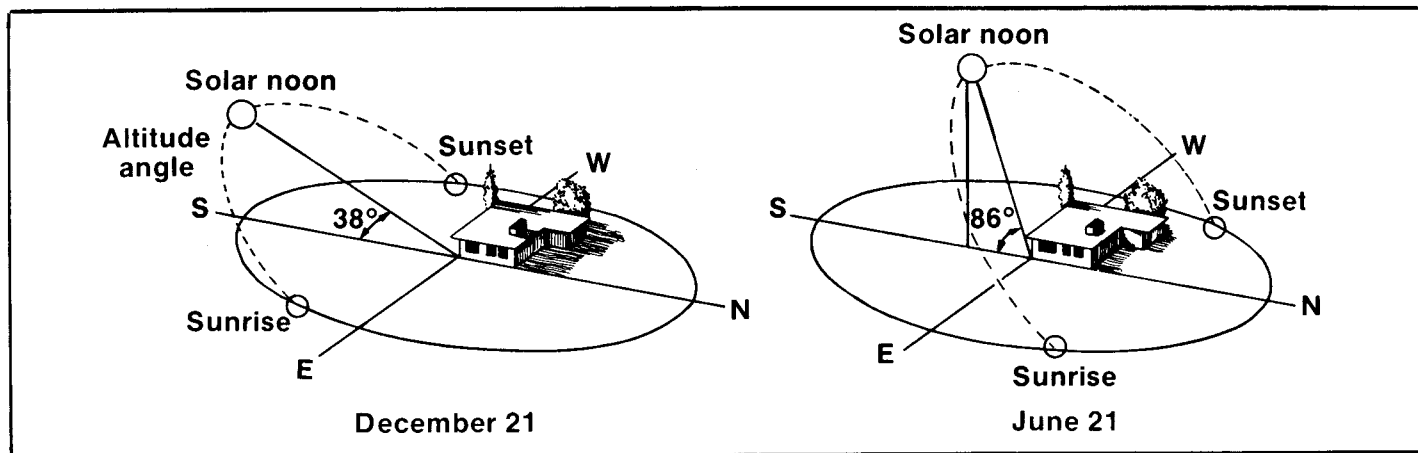

Figure 1. Sun path diagrams for 28° north.

ter the sun rises south of due east, to a maximum elevation of about 38° above the horizon at noon, and sets south of due west. In summer, the sun rises north of due east, to an elevation of about 86° at noon, and sets north of due west.

The compass directions (azimuths) of the sun at sunrise and sunset, as well as its maximum elevation angle for a given day of the year, vary with the latitude of the observer. The approximate coordinates of a particular Florida location can be determined with the aid of the Figure 2 map.

Sun Path Diagrams

To determine the path of the sun through the sky for a given location, first identify which zone you are in (using Figure 2); sun paths can then be ascertained from Figures 3 through 5. All times are solar time, solar noon being the time of maximum solar elevation locally. A procedure for converting from solar to local standard time, or vice

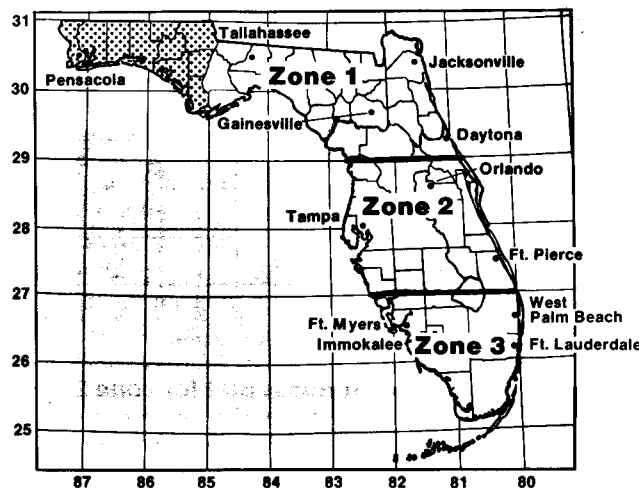

Figure 2. Map of Florida showing zones for calculating sun positions.

the predicted values by a small amount. For sun path diagrams for locations outside Florida, see references 1 and 2.

Once the appropriate sun path diagram has been selected for a given location, one can determine the extent of shading produced by various obstructions, or the times of day and year when direct solar radiation can strike points within a building through openings in the walls and roof. The key to doing this is the determination of the azimuth (or bearing) and elevation angles of the **corners** of the shading objects relative to the point of interest.

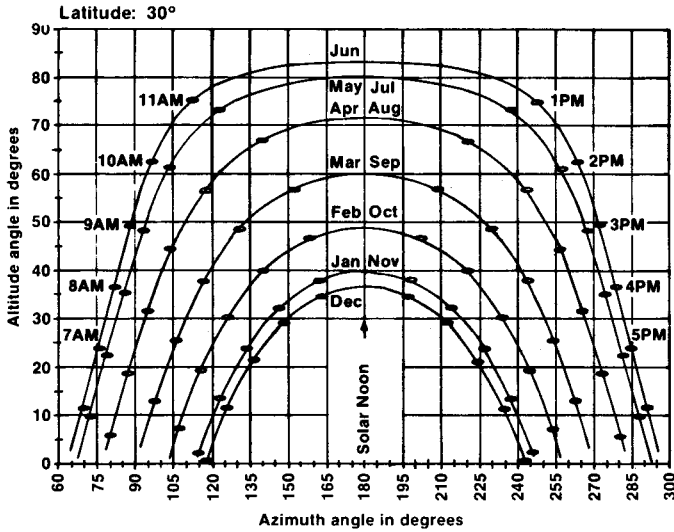

Figure 3. Sunpath plot for zone 1.

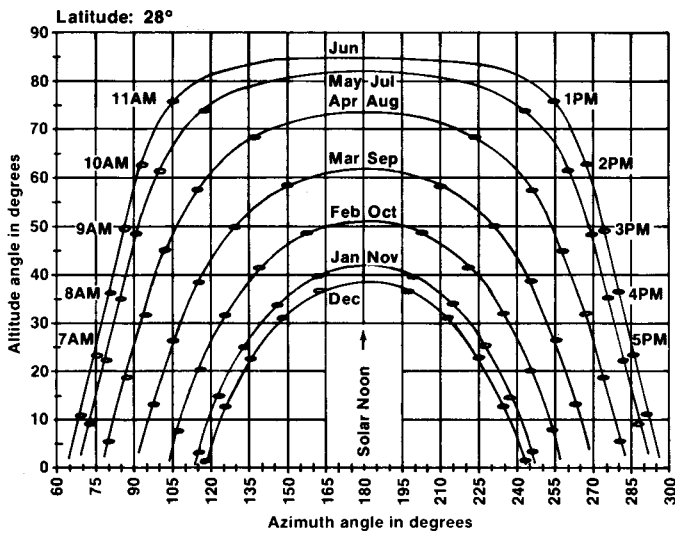

Figure 4. Sunpath plot for zone 2.

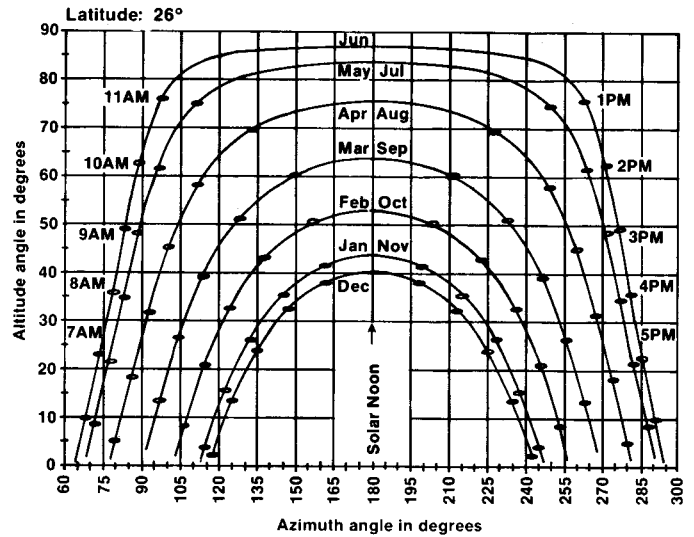

Figure 5. Sunpath plot for zone 3.

Opaque Shading Objects

For example, suppose a solar collector is planned for a site which has a tall building to the southeast of it as depicted in Figure 6. If the top two corners of this building closest to the site have elevation angles of 55° and 65° respectively above the horizon relative to the proposed site, and if their corresponding azimuth angles (measured clockwise from north) are 135° and 105° respectively, then these two points may be connected by a line on the sun path diagram as shown in figure 7. The space on the sun path diagram directly below this plotted line segment indicates the dates and times when the proposed site will be shaded by the building.

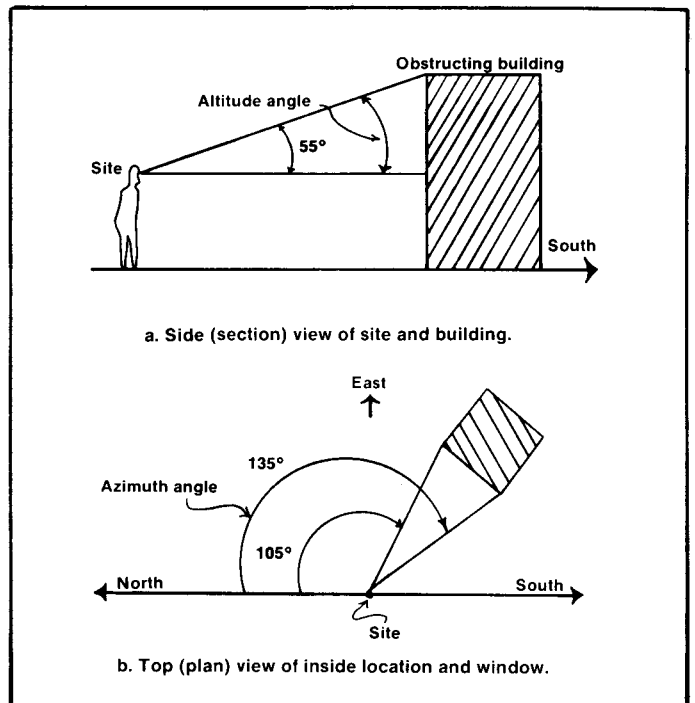

Figure 6. Locating the altitude (a) and azimuth (b) angles of a potentially obstructing building.

Note: $8\frac{1}{2}$ X 11" enlargements of Figures 3-5 and Figure 11 (which can be used directly or to produce transparencies) are available on request. Write to the FSEC Public Information Office, Cape Canaveral, FL 32920

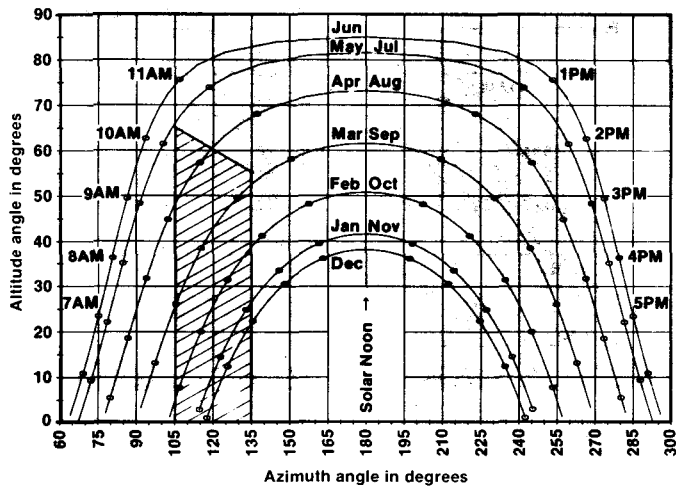

Figure 7. Identifying times of direct solar shading produced by a building southeast of the site.

Windows

The entry of direct solar radiation through a window or skylight to a point inside the building can similarly be predicted by plotting the coordinates of the corners of the aperture on a sun path diagram. (See Figures 8 and 9.) Note that if a roof overhang or other exterior structure is visible through the window it is the coordinates of this structure that must be used for that portion of the aperture.

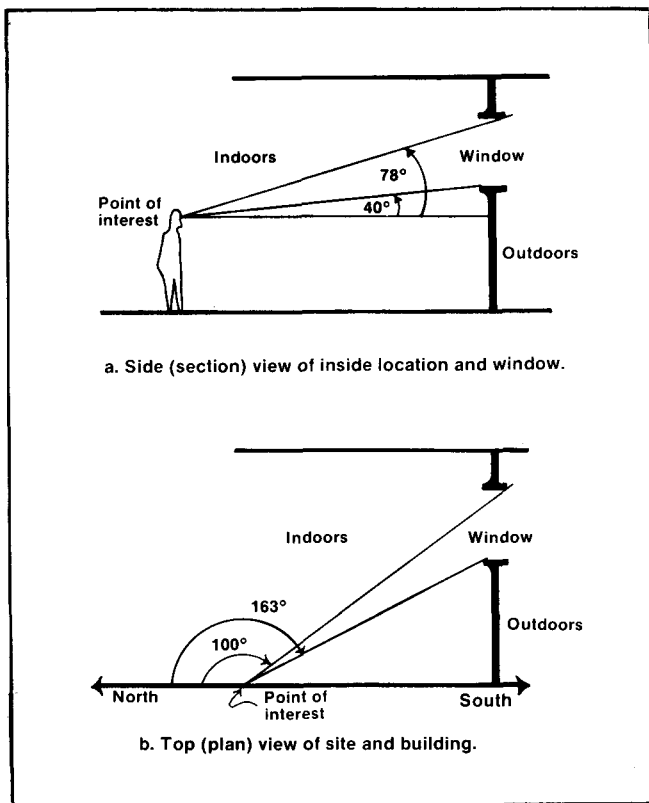

Figure 8. Locating the altitude (a) and azimuth (b) angles of the four corners of a window.

Figure 9. Identifying times of direct solar transmission through a window on the southeast side of a building to a particular location in the interior.

Roof Overhangs

Let H be the height of a roof overhang above a point on a wall of interest (which may be either the top or bottom of a window, or some other aperture). Let W be the width of the overhang from the outside wall. The ratio H/W is called the overhang ratio.

Referring to Figure 11 let Φ_0 be the azimuth angle (clockwise from north) of a perpendicular to the wall. (Φ_0 is the compass direction toward which the wall faces.) Let Φ be the azimuth angle of the sun, and let $\Delta\Phi$ be the relative solar azimuth angle, the azimuth angle of the sun from the perpendicular to the wall.

It can be shown that the altitude angles Θ , and relative solar azimuth angles for points along the edge of the roof overhang are related by the following equation, which is called the roof overhang shading transition curve:

$$\Theta = \arctan \frac{H}{W} \frac{1}{\sqrt{1 + \tan^2 \Delta\Phi}}$$

This equation has been evaluated for several different values of the overhang ratio, and the results are plotted in Figure 12.

A tracing (or photograph with no magnification) of this figure on transparent plastic or paper can be placed over the appropriate sun path diagram to easily identify the times of shading of the point on the wall. The short vertical line in this tracing at zero relative azimuth should be placed to coincide with the azimuth angle of the wall on one of the sun path plots, in Figure 3 - 5. The desired shading transition curve can then be easily identified on the sun path plot, as is illustrated in Figure 12. Once this curve has been drawn on the sun path plot for your zone, it is easy to determine the days and hours of the year (below the line) when direct sunlight will reach the point on the wall (or a window) of interest. The point never receives direct solar radiation for times above the curve in Figure 12.

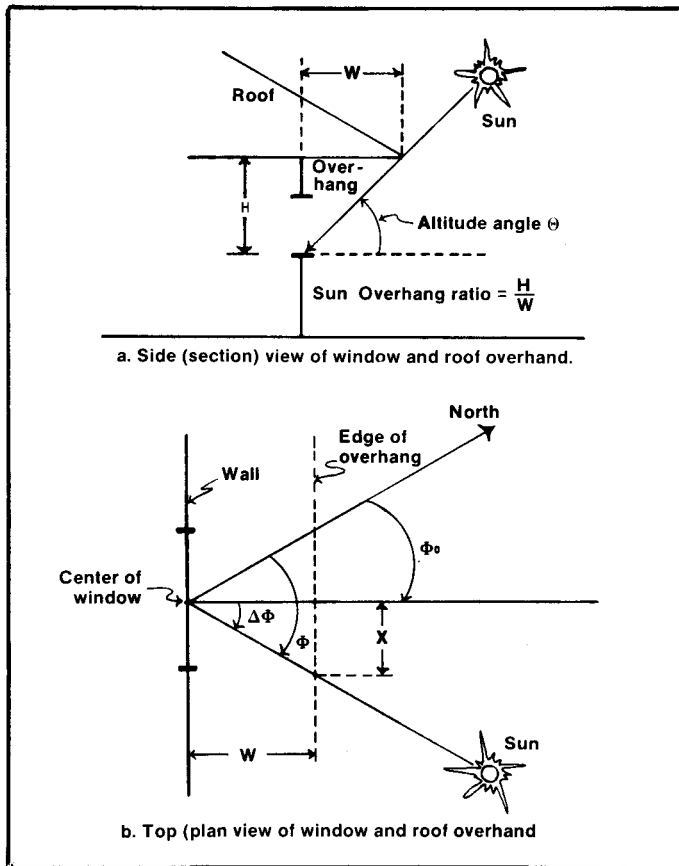

Figure 10. Locating the altitude (θ) and relative azimuth ($\Delta\phi$) angles of various points along the edge of a roof overhang.

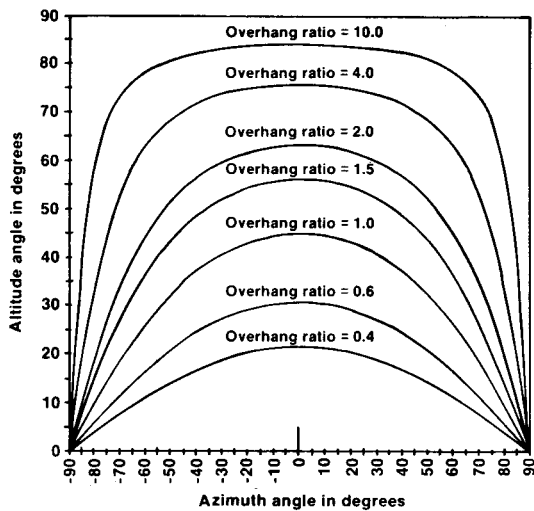

Figure 11. Roof overhang shading transition curves.

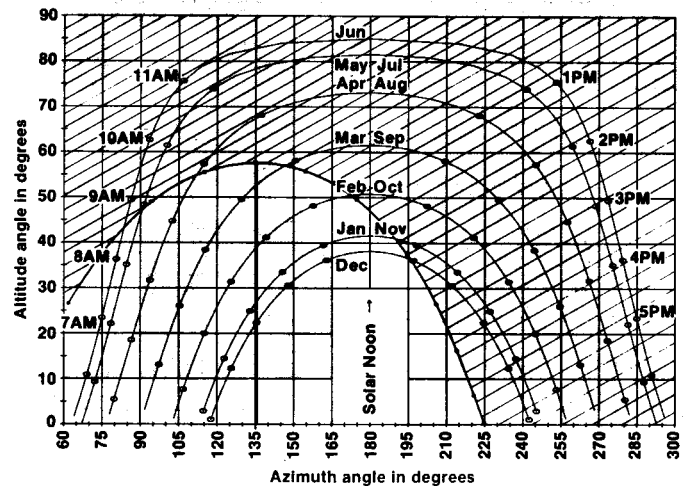

Figure 12. Roof overhang shading transition curve for a wall with 135° azimuth angle and an overhang ratio of 1.5.

Selected References

1. Bennett, Robert, *Sun Angles for Design*, 6 Snowden Road, Bala Cynwyd, PA 19004.
2. "Sunpath Diagrams," HP User's Library, 1000 N.E. Circle Blvd., Corvallis, OR 97330.
3. R. McCluney, *Roof Overhangs and Solar Time* (supplement to *Sun Position in Florida*), FSEC-RM-5-80 (RD) Public Information Office, Florida Solar Energy Center, Cape Canaveral, FL 32920.

© Copyright 1983 by Florida Solar Energy Center.